

GRAND PREMIER

COLLECTION 2024



BACUA

INNOVATION & DESIGN

MODELO: Vallarta

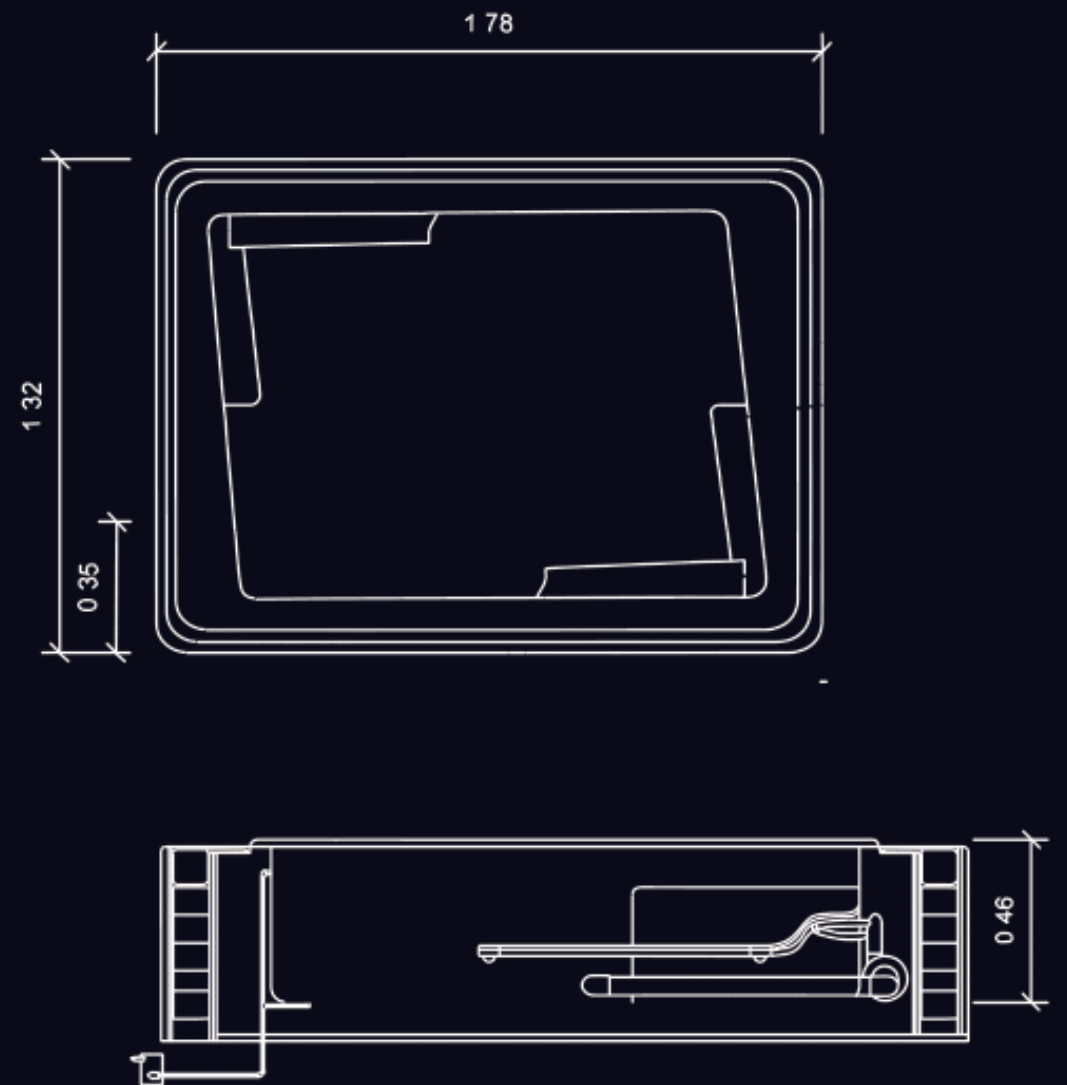

GRAND PREMIER

Equipamiento

Cantidades

	BOTÓN DE ENCENDIDO:	1
	CONTROL DE AIRE REGULABLE:	2
	BIG JETS:	6
	SMART JETS:	2
	MOTOBOMBA:	1.0 HP
	AGARRADERAS CROMADAS:	2
	ALMOHADILLA:	N/A
	AROMATERAPIA:	1
	CROMOTERAPIA:	2 - 12v.*
	CALENTADOR ELÉCTRICO:	1,000w
	REJILLA:	1
	DESAGÜE:	1

ESPECIFICACIONES

Equipamiento

Cantidades

	MEDIDAS:	1.78 X 1.32 X 0.46cm
	PERSONAS:	2
	CAPACIDAD DE AGUA:	230 lts.

COLORES

LINEA

OTROS

	BLANCO
	MARFIL

OTROS COLORES SERÁN SOBRE PEDIDO SUJETO A DISPONIBILIDAD

ACCESORIOS EXTRA

Equipamiento

Características

CALENTADOR ELÉCTRICO:	3,000 Watts
LUZ CROMOTERAPIA:	12v
ALMOHADILLA:	Negras
DECK:	



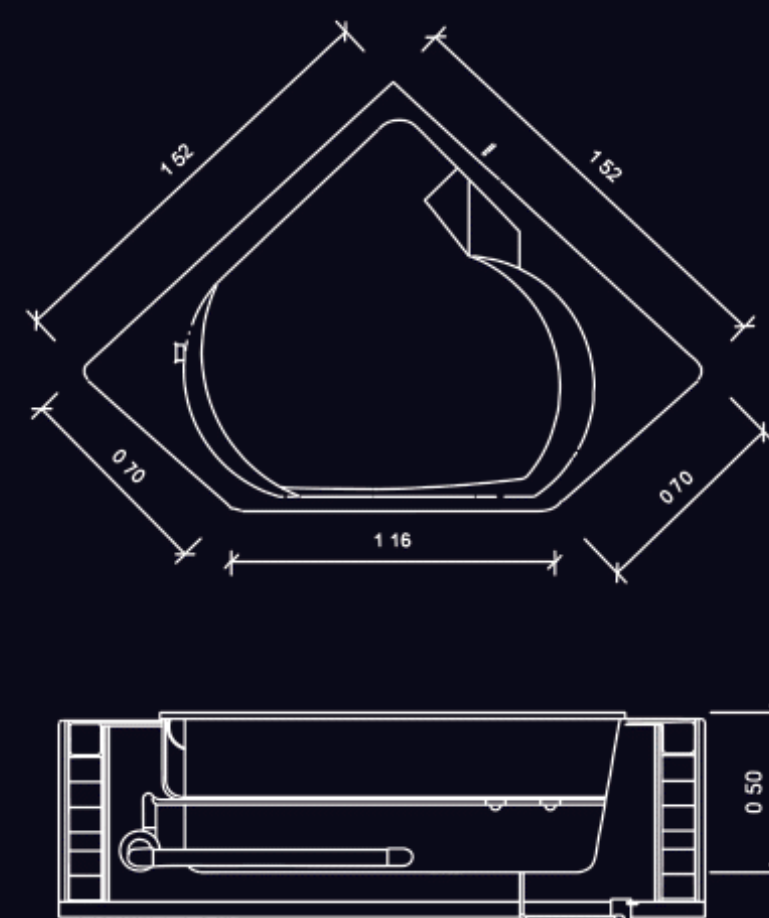









MODELO: Acapulco



GRAND PREMIER

Equipamiento



Cantidades

	BOTÓN DE ENCENDIDO:	1
	CONTROL DE AIRE REGULABLE:	2
	BIG JETS:	4
	SMART JETS:	2
	MOTOBOMBA:	1.0 HP
	AGARRADERAS CROMADAS:	1
	ALMOHADILLA:	N/A
	AROMATERAPIA:	1
	CROMOTERAPIA:	1 - 12v:*
	CALENTADOR ELÉCTRICO:	1,000w
	REJILLA:	1
	DESAGÜE:	1

ESPECIFICACIONES

Equipamiento



Cantidades

	MEDIDAS:	1.52 X 1.52 X 0.50cm
	PERSONAS:	2
	CAPACIDAD DE AGUA:	180 lts.

COLORES

LINEA

OTROS

	BLANCO
	MARFIL

OTROS COLORES SERÁN SOBRE PEDIDO SUJETO A DISPONIBILIDAD

ACCESORIOS EXTRA

Equipamiento

Características

CALENTADOR ELÉCTRICO:	1,500 Watts
LUZ CROMOTERAPIA:	12v
ALMOHADILLA:	Negras
DECK:	

MODELO: Aruba

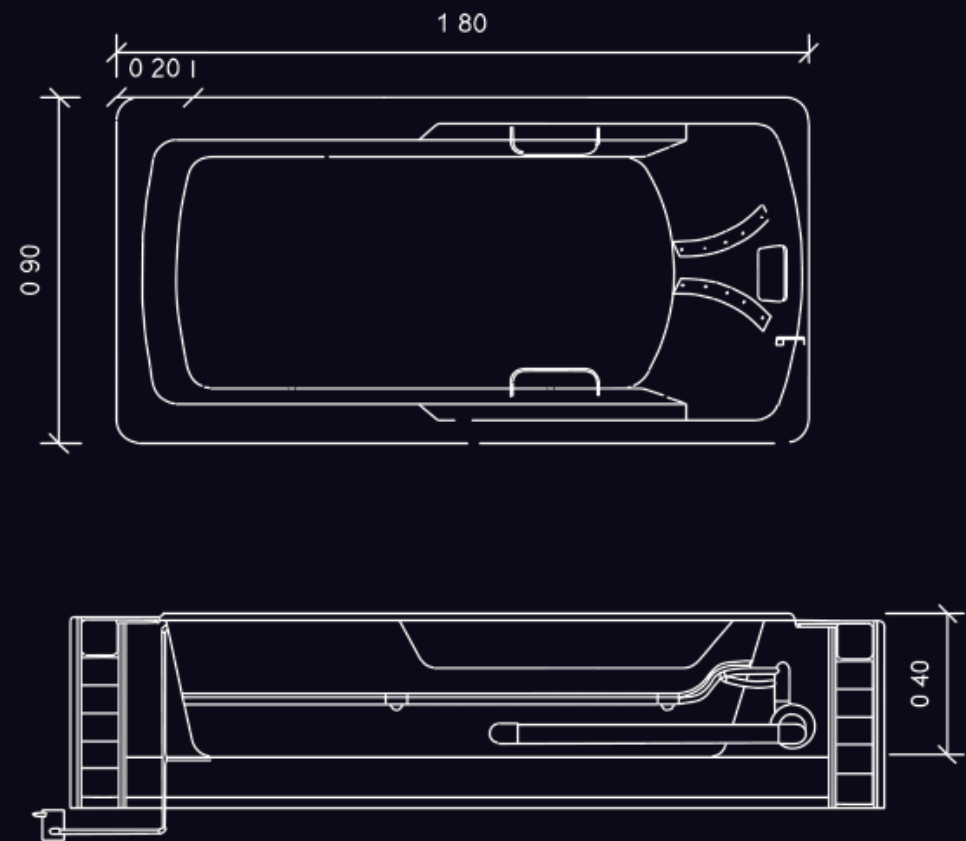
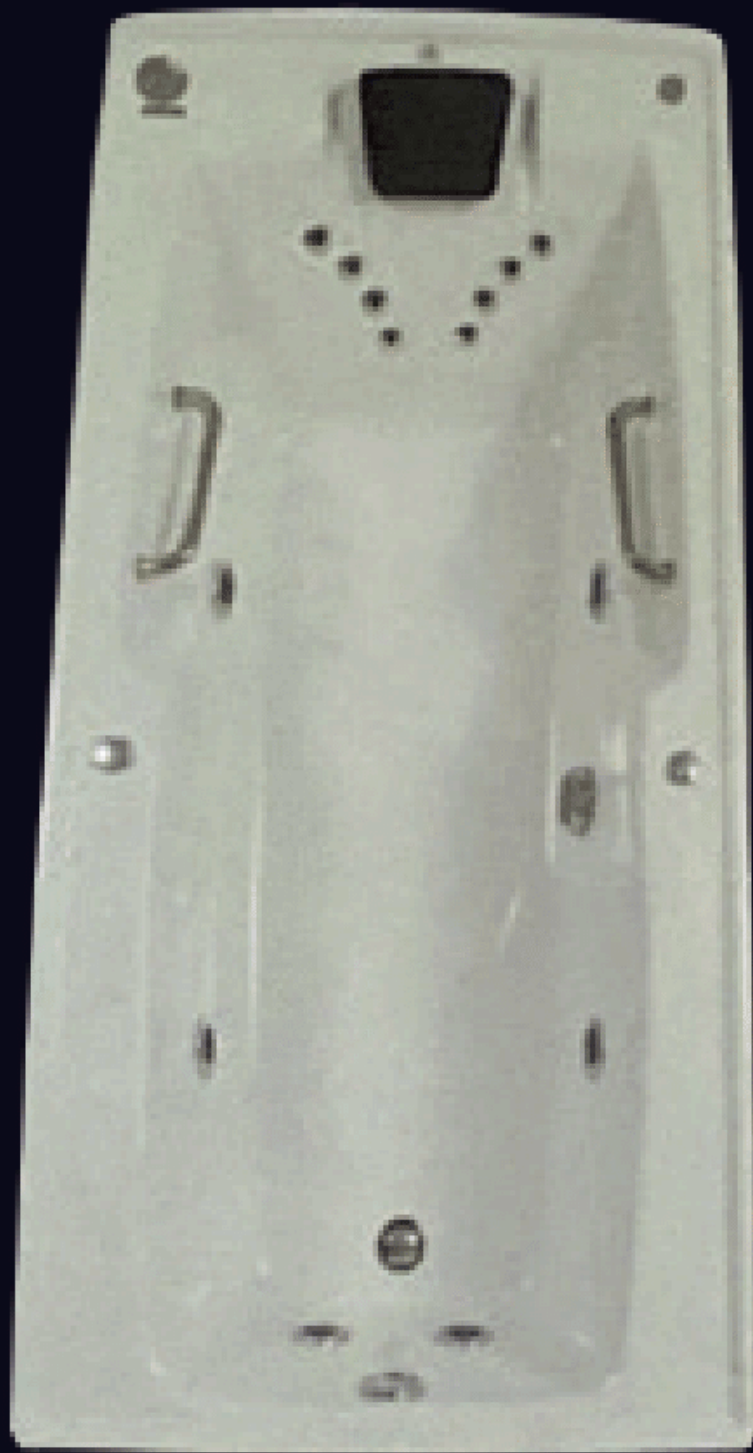

GRAND PREMIER

Equipamiento



Cantidades

	BOTÓN DE ENCENDIDO:	1
	CONTROL DE AIRE REGULABLE:	2
	BIG JETS:	8
	SMART JETS:	6
	MOTOBOMBA:	1.0 HP
	AGARRADERAS CROMADAS:	2
	ALMOHADILLA:	N/A
	AROMATERAPIA:	1
	REJILLA:	1
	DESAGÜE:	1

ESPECIFICACIONES



Equipamiento

Cantidades

	MEDIDAS:	1.80 X 0.90 X 0.40cm
	PERSONAS:	1
	CAPACIDAD DE AGUA:	165 lts.

COLORES

LINEA

	BLANCO
	MARFIL

OTROS

OTROS COLORES SERÁN SOBRE PEDIDO SUJETO A DISPONIBILIDAD

ACCESORIOS ADICIONALES

Equipamiento

Características

CALENTADOR ELÉCTRICO:	1500 Watts
LUZ CROMOTERAPIA:	12v
ALMOHADILLA:	Negras

MODELO: Miami

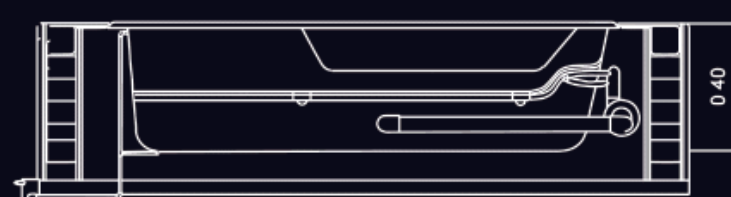
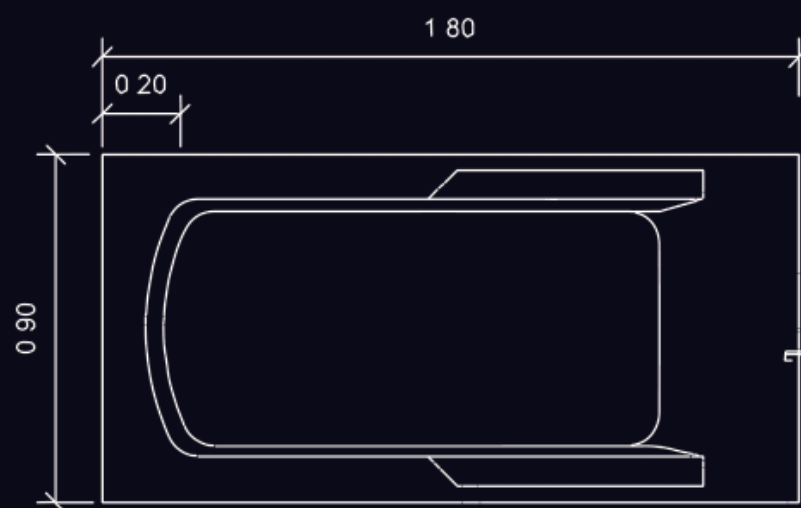
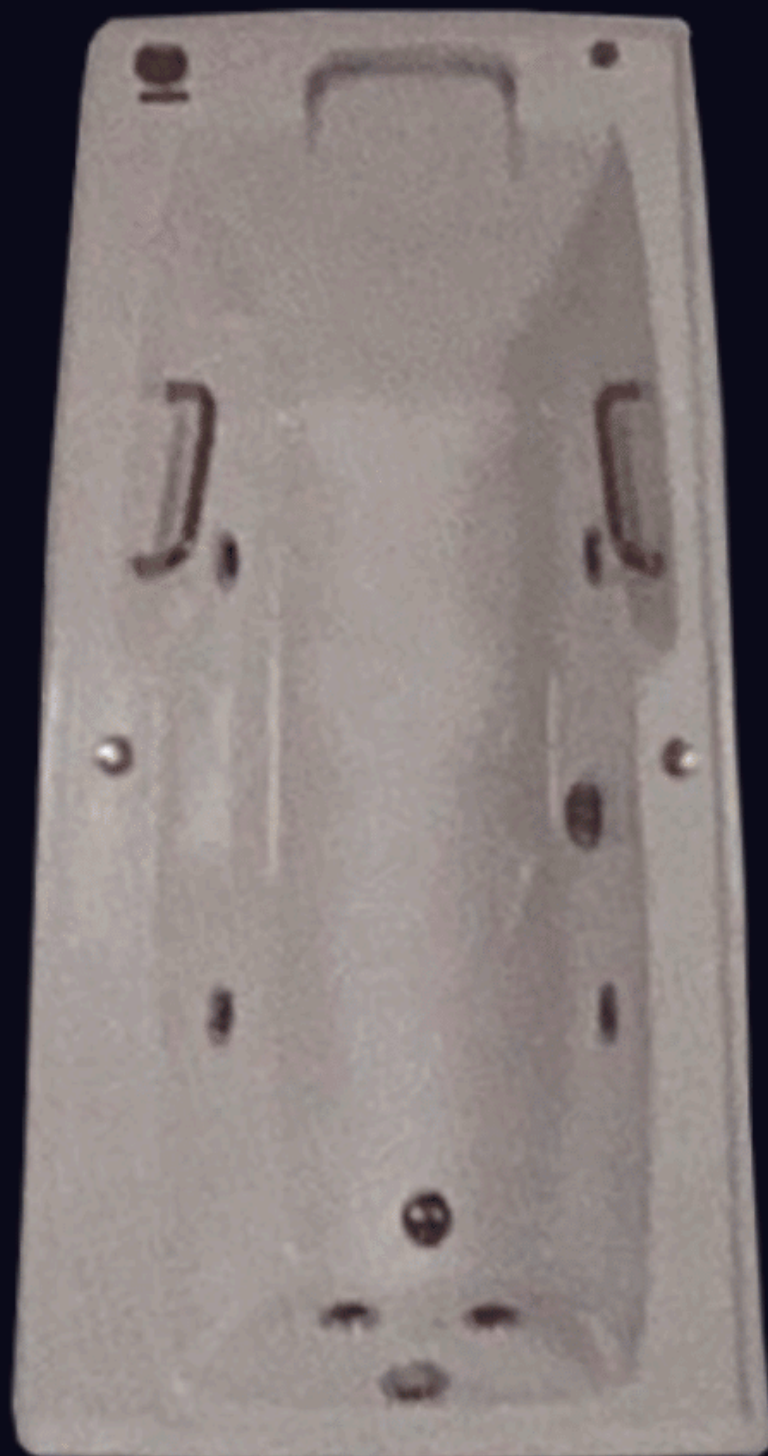

GRAND PREMIER

Equipamiento



Cantidades

	BOTÓN DE ENCENDIDO:	1
	CONTROL DE AIRE REGULABLE:	2
	BIG JETS:	4
	SMART JETS:	2
	MOTOBOMBA:	1.0 HP
	AGARRADERAS CROMADAS:	2
	ALMOHADILLA:	N/A
	AROMATERAPIA:	1
	REJILLA:	1
	DESAGÜE:	1

ESPECIFICACIONES



Equipamiento

Cantidades

	MEDIDAS:	1.80 X 0.90 X 0.40cm
	PERSONAS:	1
	CAPACIDAD DE AGUA:	150 lts.

COLORES

LINEA

	BLANCO
	MARFIL

OTROS

OTROS COLORES SERÁN SOBRE PEDIDO SUJETO A DISPONIBILIDAD

ACCESORIOS ADICIONALES

Equipamiento

Características

CALENTADOR ELÉCTRICO:	1500 Watts
LUZ CROMOTERAPIA:	12v
ALMOHADILLA:	Negras



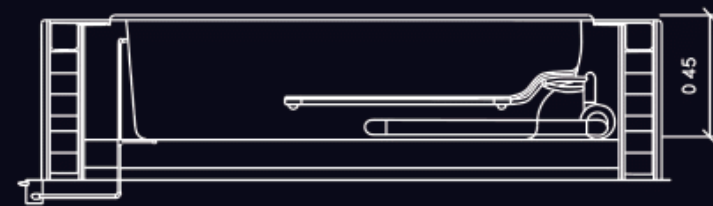
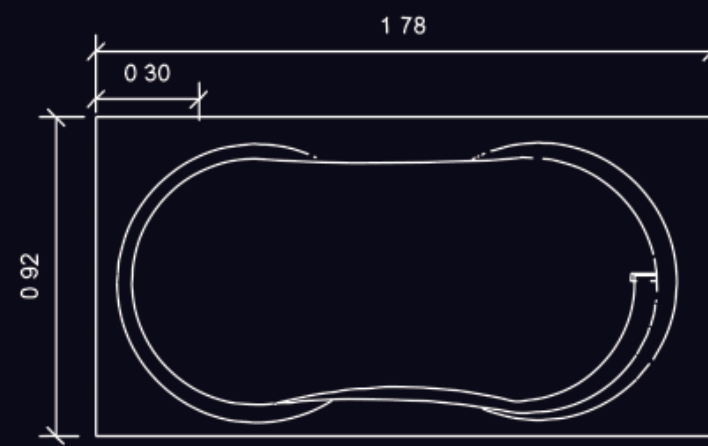



MODELO: Caribe



GRAND PREMIER

Equipamiento

Cantidades

	BOTÓN DE ENCENDIDO:	1
	CONTROL DE AIRE REGULABLE:	2
	BIG JETS:	4
	SMART JETS:	3
	MOTOBOMBA:	1.0 HP
	AGARRADERAS CROMADAS:	N/A
	ALMOHADILLA:	N/A
	AROMATERAPIA:	1
	REJILLA:	1
	DESAGÜE:	1

ESPECIFICACIONES

Equipamiento



Cantidades

	MEDIDAS:	1.78 X 0.92 X 0.45cm
	PERSONAS:	1
	CAPACIDAD DE AGUA:	160 lts.

COLORES

LINEA

OTROS

	BLANCO
	MARFIL

OTROS COLORES SERÁN SOBRE PEDIDO SUJETO A DISPONIBILIDAD

ACCESORIOS ADICIONALES

Equipamiento

Características

CALENTADOR ELÉCTRICO:	1500 Watts
LUZ CROMOTERAPIA:	12v
ALMOHADILLA:	Negras

MODELO: Jamaica

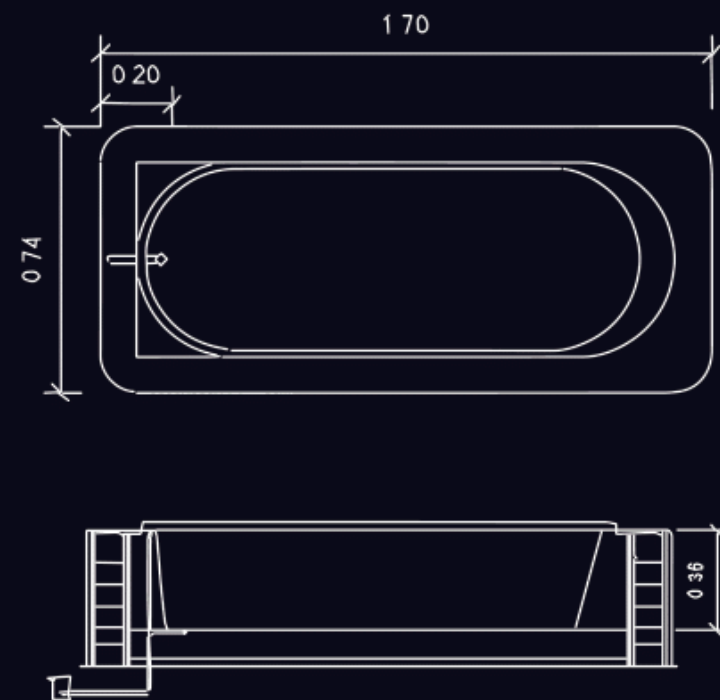

GRAND PREMIER		
Equipamiento		Cantidades
BOTÓN DE ENCENDIDO:		2
CONTROL DE AIRE REGULABLE:		2
JETS:		11
BLOWERS:		10
MOTOBOMBA:		1.0 HP
MOTOBOMBA BLOWERS:		1.0 HP
AGARRADERAS CROMADAS:		2
ALMOHADILLA:		N/A
AROMATERAPIA:		1
REJILLA:		1
DESAGUE:		1

ESPECIFICACIONES		
Equipamiento		Cantidades
MEDIDAS:		1.57 X 0.87 X 0.46cm
PERSONAS:		1
CAPACIDAD DE AGUA:		160 lts.
COLORES		
LINEA		OTROS
BLANCO		OTROS COLORES SERÁN SOBRE PEDIDO SUJETO A DISPONIBILIDAD
MARFIL		
ACCESORIOS ADICIONALES		
Equipamiento		Características
CALENTADOR ELÉCTRICO:		1500 Watts
LUZ CROMOTERAPIA:		12v
ALMOHADILLA:		Negras



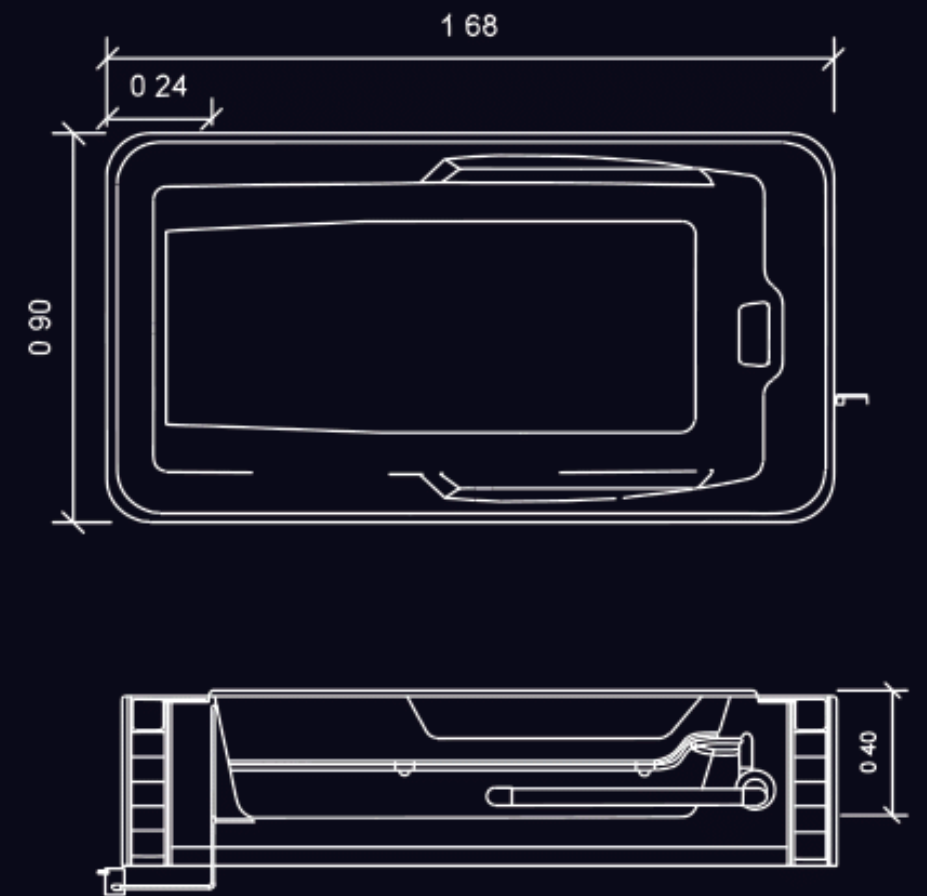







MODELO: Bahía



GRAND PREMIER

Equipamiento

Cantidades

	BOTÓN DE ENCENDIDO:	2
	CONTROL DE AIRE REGULABLE:	2
	JETS:	7
	BLOWERS:	10
	MOTOBOMBA:	1.0 HP
	MOTOBOMBA BLOWERS:	1.0 HP
	AGARRADERAS CROMADAS:	2
	ALMOHADILLA:	1
	AROMATERAPIA:	1
	REJILLA:	1
	DESAGUE:	1

ESPECIFICACIONES

Equipamiento



Cantidades

	MEDIDAS:	1.68 X 0.90 X 0.40cm
	PERSONAS:	1
	CAPACIDAD DE AGUA:	140 lts.

COLORES

LINEA

OTROS

	BLANCO
	MARFIL

OTROS COLORES SERÁN SOBRE PEDIDO SUJETO A DISPONIBILIDAD

ACCESORIOS EXTRA

Equipamiento

Características

CALENTADOR ELÉCTRICO:	1,500 Watts
LUZ CROMOTERAPIA:	12v
ALMOHADILLA:	Negras
DECK:	

COLLECTION
2024

